

The Atlas Copco logo is positioned in the top right corner of the image. It consists of the company name "Atlas Copco" in a white, serif font, centered between two horizontal white bars. The logo is set against a blue rectangular background that is part of the overall design.A technical drawing of a gas screw compressor is overlaid on a blue triangular graphic in the bottom left corner. The drawing shows various components and dimensions of the compressor, including a circular cross-section with a diameter of 1300 (64.21) and a length of 1300 (64.51). Other dimensions include 10.8, 16.5, 30.8, 10.5, and 41.8. The drawing is rendered in white lines on a blue background.

First choice for biogas upgrading and biomethane gas injection

GG oil-lubricated gas screw compressor

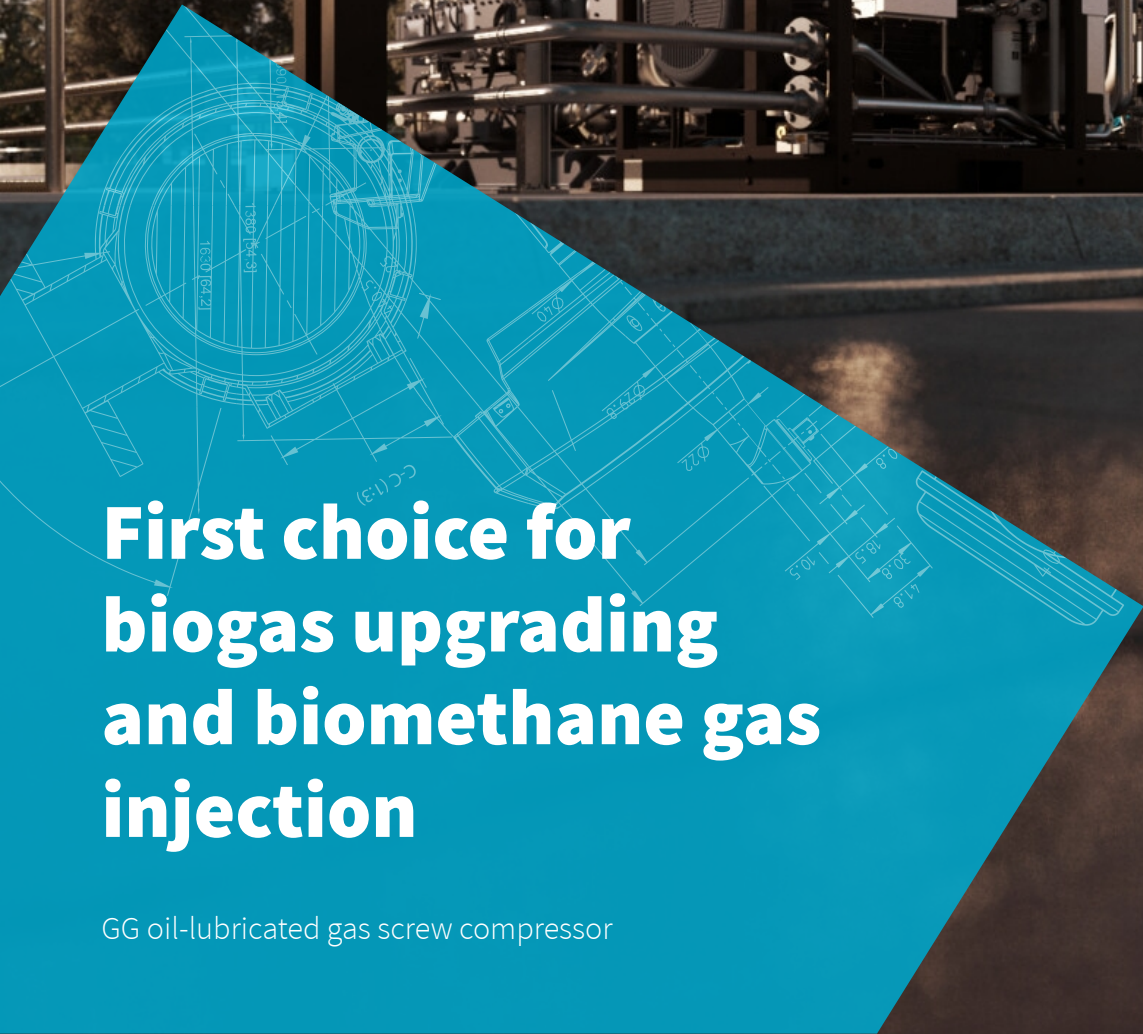

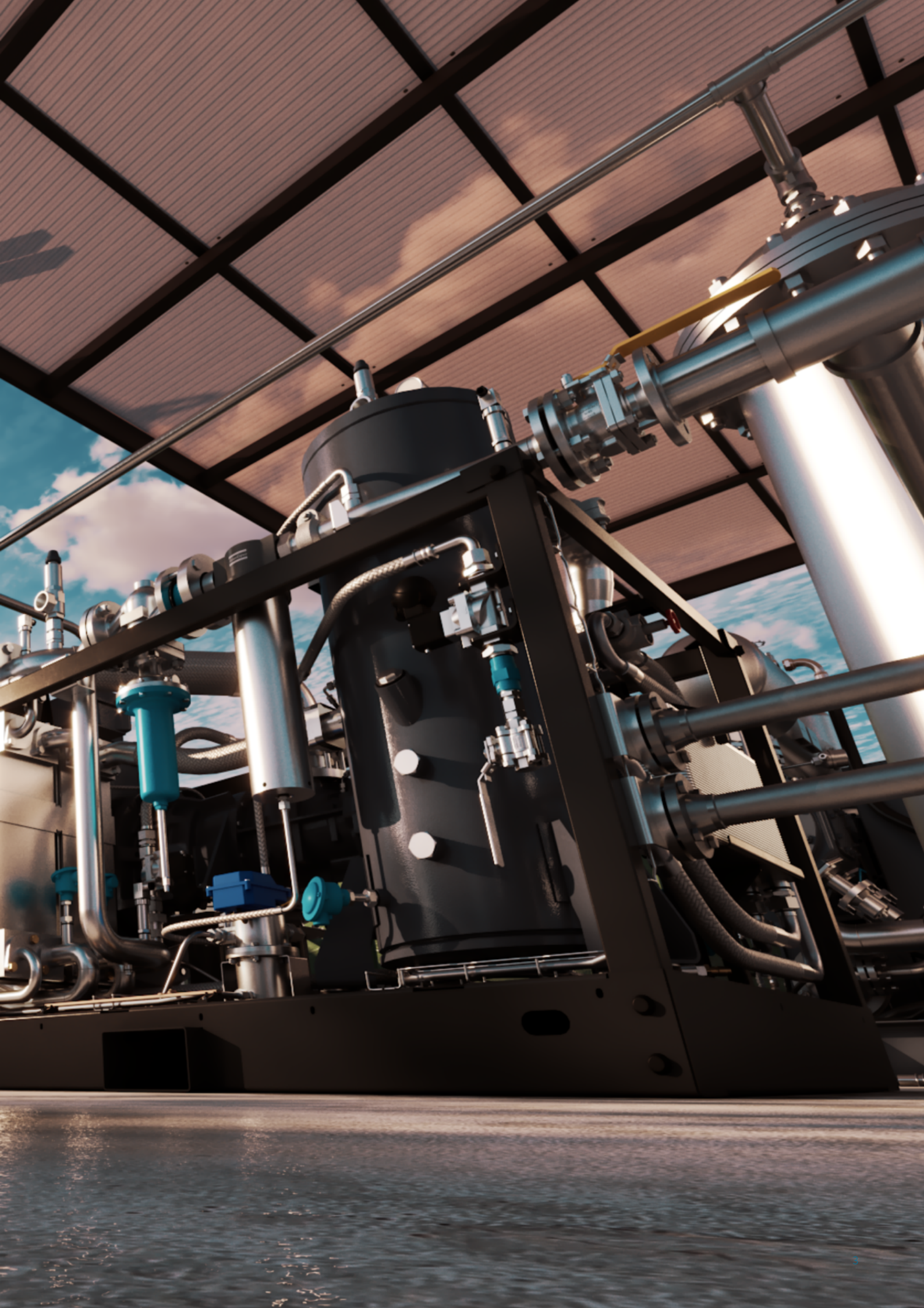



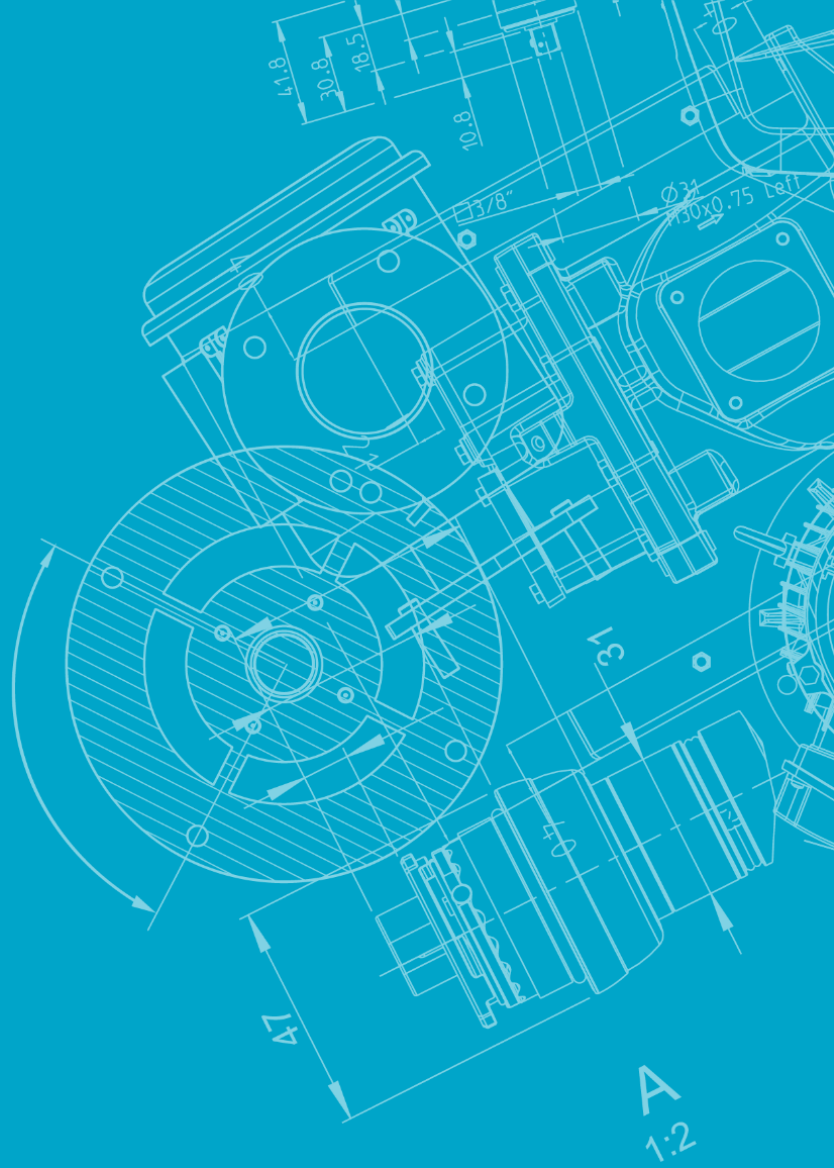

Contents

1

Front cover

6

Introduction

8

The biogas journey

9

Our solution

12

Innovation for efficiency and cost savings

14

Optimal gas quality

15

Highest reliability, lowest operating costs

16

Working principle

17

Why Atlas Copco?

18

Optimize your system

20

Technical specifications

22

Back cover

Leading innovation for a circular economy

Biogas is a key resource in the fight against climate change, offering a virtually carbon-neutral way to replace fossil fuels, reduce greenhouse gas emissions and build a circular economy. As well as providing a renewable energy source, it contributes to proper management of waste by creating opportunities to reuse it as a source of power for manufacturing.

Atlas Copco has been a pioneer in this exciting innovation since the 1980s and has accumulated extensive knowledge and experience in the fields of biogas upgrading, biomethane grid injection, natural gas boosting, and vehicle fueling. The GG series of gas screw compressors brings market-leading reliability and the benefits of Variable Speed Drive (VSD) technology to the field of methane and biomethane gas grid injection. While offering constant discharge pressure at flow levels up to 1000 Nm³/h, these super-efficient machines will cut your energy requirements by adapting motor speeds to production demands.





Reliability & durability

Built for smooth, dependable operation with low maintenance



Safety

Tailored for the challenges of gases handling



Energy efficiency

Cost savings with VSD and adapted capacity control



Optimal gas quality

Gas-tight and oil-free to protect your system



Atlas Copco expertise

First-class service and availability from a name you can trust



From organic waste to energy source: the biogas journey

Raw biogas is produced via anaerobic digestion, a process in which organic matter such as animal or food waste is broken down to produce biogas and biofertilizer. This happens in the absence of oxygen, in an anaerobic digester. Raw biogas from animal waste contains around 55% methane, 35% CO₂ and traces of other gases such as H₂S and other VOCs. In the final stages of production (upgrading), CO₂ is removed from the raw biogas and compressed.

Capturing and compressing this CO₂ is an essential part of the journey. Rather than being released into the atmosphere and triggering unwanted climate effects, it can be reused, injected into a CO₂ pipeline, or stored underground.



Scan the QR code for more information
Explore our interactive
digital brochure for a 360
immersive experience.



Engineered for reliability

GG compressors are designed specifically to meet the high demands of biogas upgrading and gas grid applications. Along with maximum efficiency, we prioritized safe handling and reliable generation with the quality you need. Explore the highlights below to find out more.

GG oil-lubricated gas screw compressor

LEFT SIDE

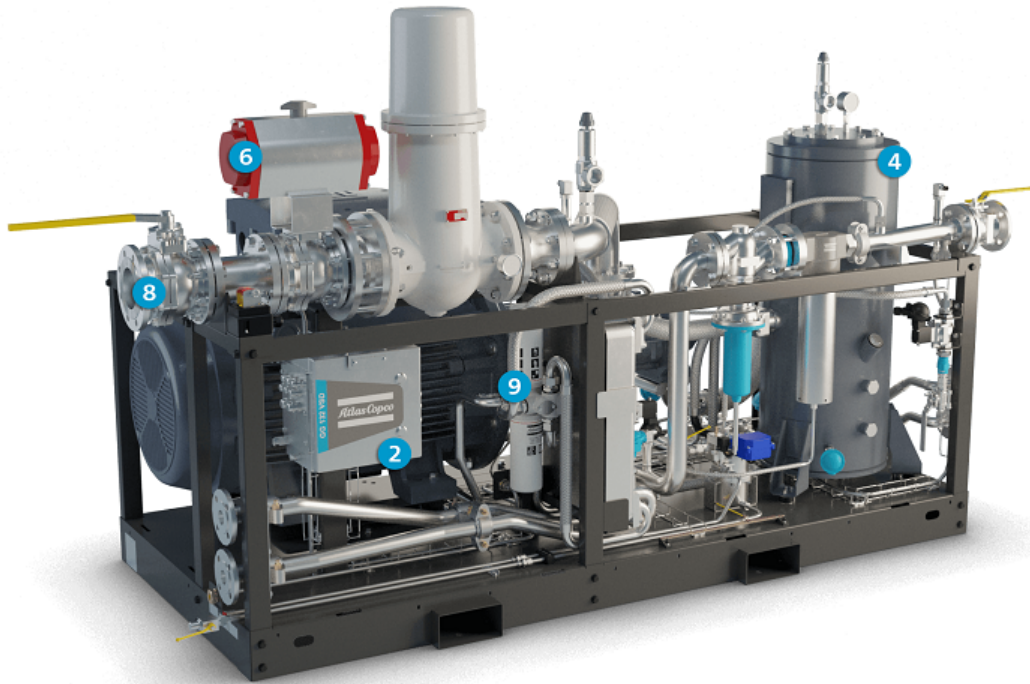

RIGHT SIDE

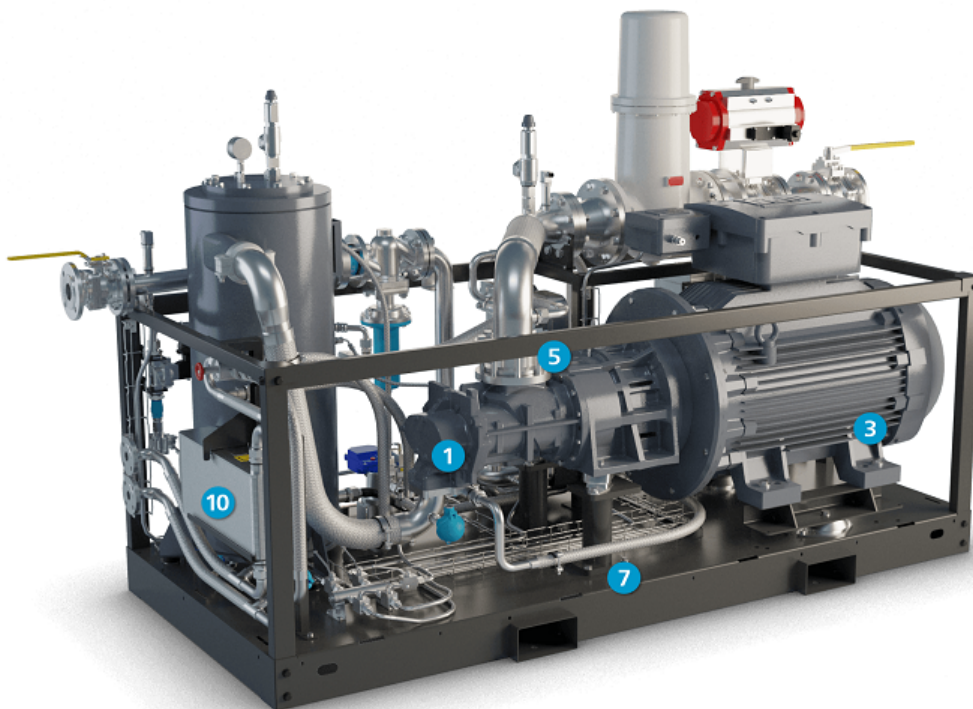

1 High efficiency gas screw

- Single stage, oil lubricated, with superior mechanical shaft seal.
- Rotors maximize gas flow at low energy cost.

2 Junction box

- Safe, explosion-proof.
- Stainless steel enclosure.
- Easily accessible connections to control cubicle.



3 Safe electric motor with Variable Speed Drive

- IP55 – IEC – 400 V/50 Hz – Eexd IIB T4.
- Flexible coupling.

4 High-performance oil separator

- Oil residue in gas down to 5 ppm.
- Contributes to preserve the components in your gas upgrading process.
- Longer interval between oil top-ups reduces maintenance costs.

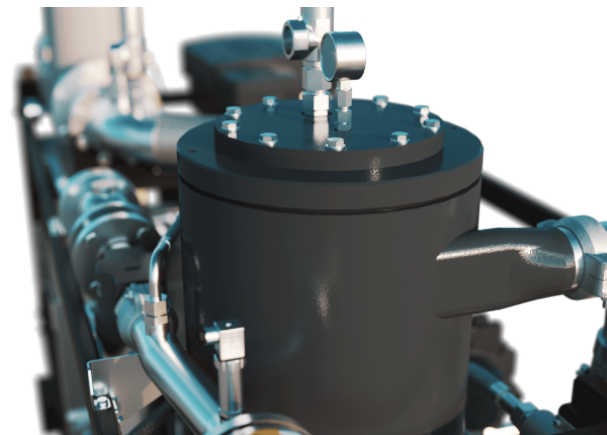

5 No back-flow

Non-return valve prevents risk of back-flow of oil, protecting the gas net.

6 Gas inlet valve

Closed on emergency stop, isolating compressor from gas supply.

7 Frame: compact, plug & play

- All equipment fitted on baseframe.
- Cable protection with stainless steel trays.
- Slots for forklift handling.
- Easily accessible connections for water, gas, and power.

8 Integrated inlet gas train

Straightforward connection with easy access for gas inlet valve and optional gas filter.

Gas filter:

- High filtration rate (efficiency).
- Upstream particle separation.
- Replaceable filter cartridges.

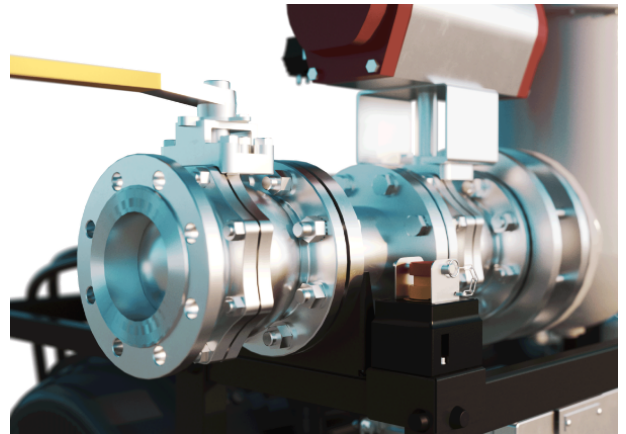

9 Oil filter & oil

The high efficiency oil filter provides superior filtration compared to conventional filters resulting in cleaner lubricant. The thermostatic bypass valve ensures that the compressor quickly reaches optimum operating temperature and maintains temperature during periods of low load. The lubricant is specifically formulated to provide limited dilution with hydrocarbon gases and features excellent protection against hydrogen sulfide in the gas stream.

10 Energy recovery

The energy recovery system consists of a built-in heat exchanger and thermostatically controlled system to recover the heat from the compressor in the form of warm water without any adverse influence on the compressor performance.

Innovation for efficiency and cost savings

Over 80% of a compressor's lifecycle cost is taken up by the energy it consumes. Moreover, the generation of compressed gas can account for a significant amount of a plant's total electricity bill. Atlas Copco has consistently addressed this challenge by innovating to cut our customers' energy costs.

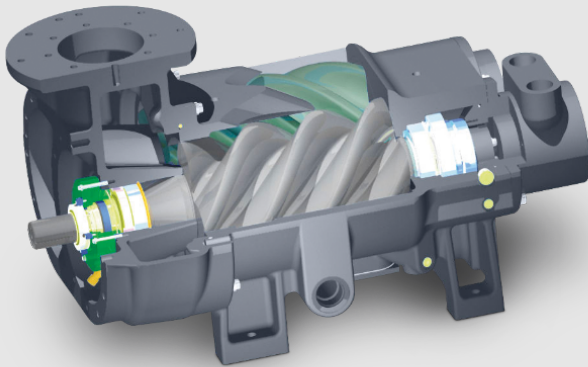

Variable Speed Drive (VSD)

Atlas Copco's Variable Speed Drive (VSD) technology closely follows the gas demand and continuously adjusts the motor speed, resulting in energy savings. Coupled with inlet pressure control, VSD maximizes flow, and minimizes required horsepower. By working less to do more, VSD consumes less power, while giving greater process control and requiring less maintenance. When the quantity of gas available from the bio process rises, the VSD motor speeds up to ensure a continuous supply of gas to the grid with very low pressure fluctuation.

Energy Recovery

Turn your compressor into an energy source. Our water-cooled gas screw compressors can be equipped with an Energy Recovery unit which helps you achieve your low-carbon economy goals. Recover up to 75% of the electrical energy which is converted into compression heat. Our Energy Recovery system uses this to heat up water that can be used for sanitary purposes, space heating, or process applications.

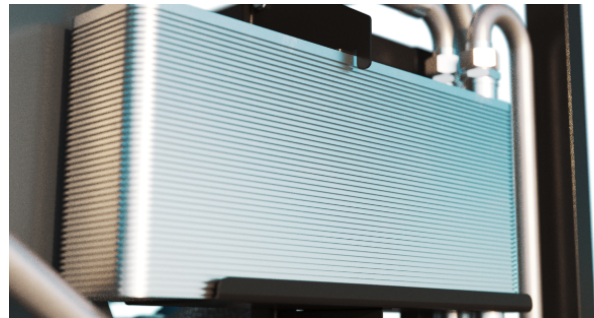

SMARTLINK

Knowing the status of your compressed gas equipment at all times is the key to optimal efficiency and availability.

Go for energy efficiency

Customized reports on the energy of your compressor room.

Increase uptime

All the components are replaced on time, ensuring maximum uptime.

Save money

Early warnings avoid breakdowns and production loss.

Electrical cabinet with Elektronikon® Mk5

Our Elektronikon® Mk5 controller is designed with energy-efficient Atlas Copco algorithms to maximize flow and minimize power consumption. It controls both the compressor and the integrated converter, ensuring maximum machine safety within parameters.

Most production processes create fluctuating levels of demand which can lead to energy waste in low use periods. Using the Elektronikon® Touch controller, you can switch between two different set points to optimize energy use and reduce costs at low use times.

- Guarantees seamless interaction
- Intrinsically safe loop
- Delivered in a safe area cubicle
- Easy integration and remote monitoring



Component designed for efficiency

- High efficiency gas screw element
- Single stage, oil lubricated, with superior mechanical shaft seal.
- Rotors maximize gas flow at low energy cost.



The gas quality you need to protect your profits

Biogas upgrading systems need to ensure correct gas quality to preserve their lifetime and performance, so a correct system helps our customers save money and downtime. Our GG products will increase your efficiency as well as your profitability.

To play an effective role in the transition to a low-carbon economy, the CO₂ resulting from biogas production needs to be compressed to a pressure of around 20 bar for reuse. Just like with our oil-free CO₂ compressors, it must also meet stringent quality criteria for industries such as food and beverage.



Gas-tight and secure

Equipment for gas compression must meet more stringent safety requirements than conventional air compressors. The GG-Series more than measures up: it is 100% gas-tight and complies with ATEX Zone 2. Security functions are handled by an SIL2 PLC (according to IEC 61508). It is fully compliant with CE directives.

Oil separator (always included)

The separator is designed to have adequate fluid cyclonic separation completed with a coalescing filter. The scavenge line allows separated oil (collected by the media filter) to be evacuated into the screw block. The design of the gas/fluid separator provides adequate fluid retention time and surface area to allow gas release from fluids.

14 - GG VSD Series

Outlet water separator and filters (option)

This is the best option to avoid liquid water going into your biogas treatment system. We offer an integrated water separator with an automatic, zero loss drain system so you can remove water safely and efficiently after compression.

Inlet filtration (option)

This enhances the longevity of the screw block and the cleanliness of the injected gas.

Highest reliability, lowest operating costs

The shortest route to maximize your profitability is to minimize your operational costs. With up to 80% of a compressor's lifecycle cost coming from the energy it consumes, this should be a clear focus. Atlas Copco's GG gas screw compressors come equipped with our state-of-the-art screw element to achieve significant energy savings while providing long and trouble-free life.



Ensuring reliable production

Designed for 24/7 industrial service, GG gas screw compressors always meet your requirements for a smooth and reliable supply of gas without the need for constant supervision. The proof of their reliability is the thousands of machines that have been operating worldwide for decades.

Maximize energy efficiency

Our VSD technology is integrated with the latest innovations in terms of monitoring and control to follow gas demand closely and continuously adjust the motor speed. This enables you to match power consumption to demand, creating further energy savings and improving regulation possibilities.

Even greener with Energy Recovery

You can turn your compressor into an energy source. Gas compressors equipped with Energy Recovery can help you achieve your goals in becoming carbon-neutral.

Global presence, local service

Our aftermarket product portfolio is designed to add maximum value for our customers by ensuring optimum availability and reliability of their compressed air equipment with the lowest possible operating costs. We deliver this complete service guarantee through our exclusive service organization, maintaining our position as leader in compressed gas.

Working principle

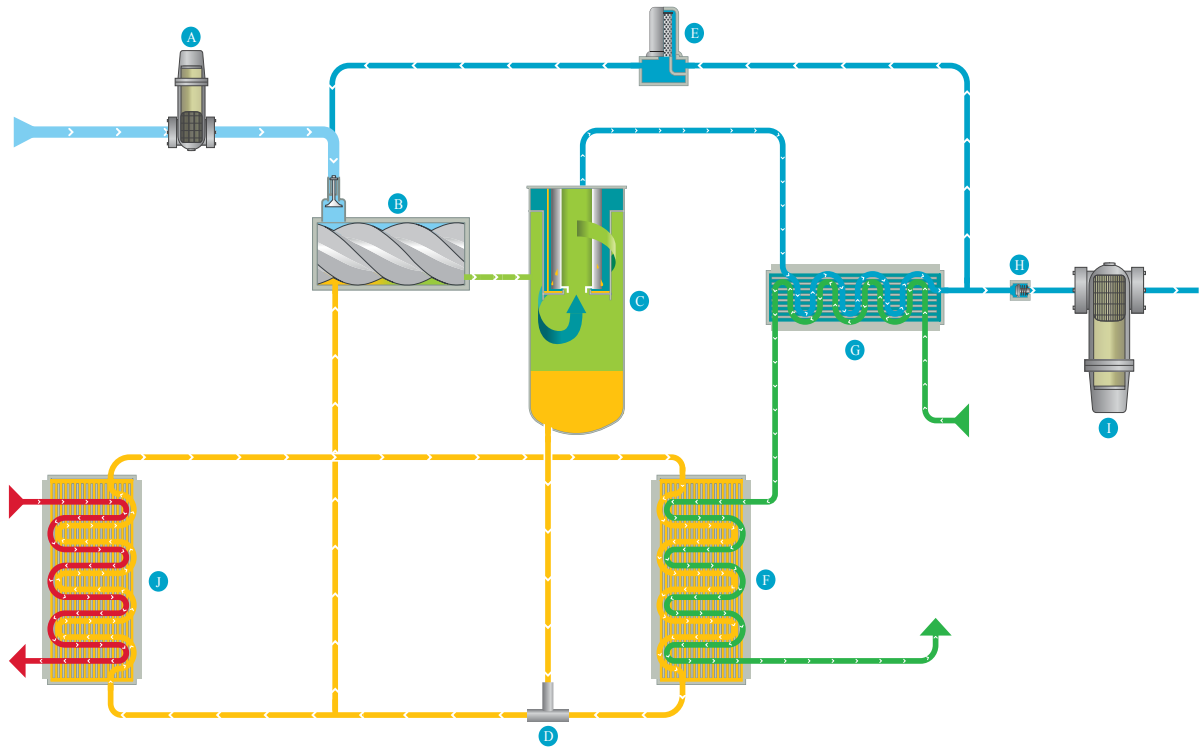

- A. Gas intake filter
- B. Screw compressor
- C. Separator vessel
- D. Thermostatic bypass valve
- E. Solenoid valve
- F. Oil cooler
- G. After cooler
- H. Minimum pressure valve
- I. Optional water separator drain
- J. Optional Energy Recovery

A name you can trust in a changing world

The industrial world is evolving fast as we transition towards new energy sources and face ever more urgent climate targets. With over 140 years of experience, Atlas Copco has built an enviable reputation as a master in compression technology. We are passionate about meeting all our customers' needs, embracing new challenges with expertise, innovation and outstanding product and component quality.

Always there for you

We care about the reputation of the business you have built. Along with first-class reliability to ensure uninterrupted production, we are committed to excellent service with strong local presence. Our expert teams are always on hand to answer questions, discuss solutions and take care of your servicing and maintenance needs.

Our portfolio includes solutions for biogas upgrading, downstream grid injection, grid boosting and vehicle fueling.

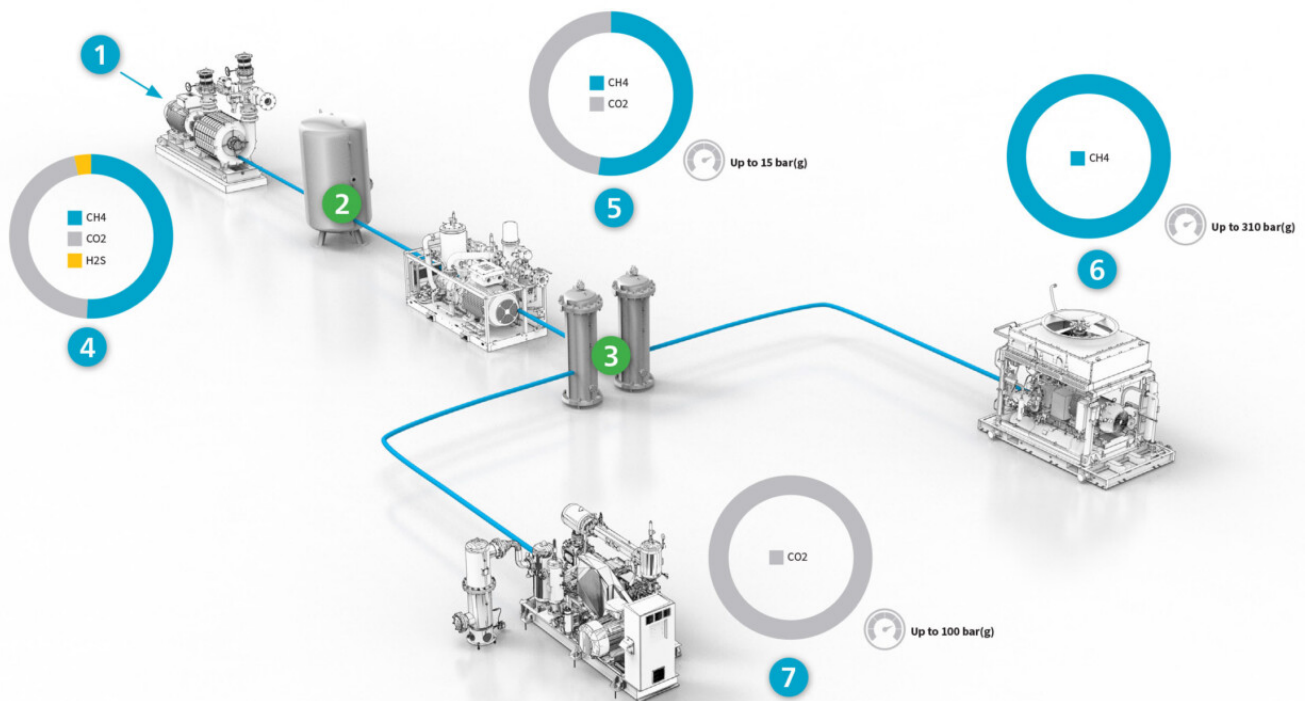

1. Raw gas
4. Lobe and centrifugal blowers (Atlas Copco scope)
2. H₂S removal
5. Screw compressors (Atlas Copco scope)
3. CO₂ removal
6. CH₄ reciprocating compressors (Atlas Copco scope)
7. CO₂ compressors (Atlas Copco scope)

Optimize your system

The GG VSD gas screw compressor is designed as a complete turnkey unit, ready for use. It is built around an efficient gas screw compressor with pre-defined instruments and controls. This arrangement allows you to either choose the complete turnkey unit or the basic compressor with the options you need. You can customize the instrumentation you need.

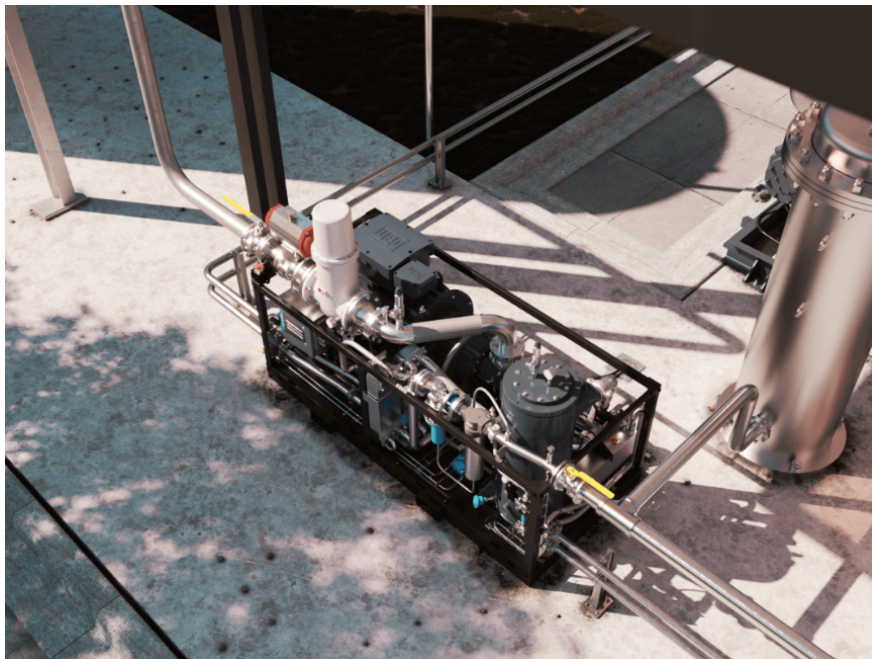
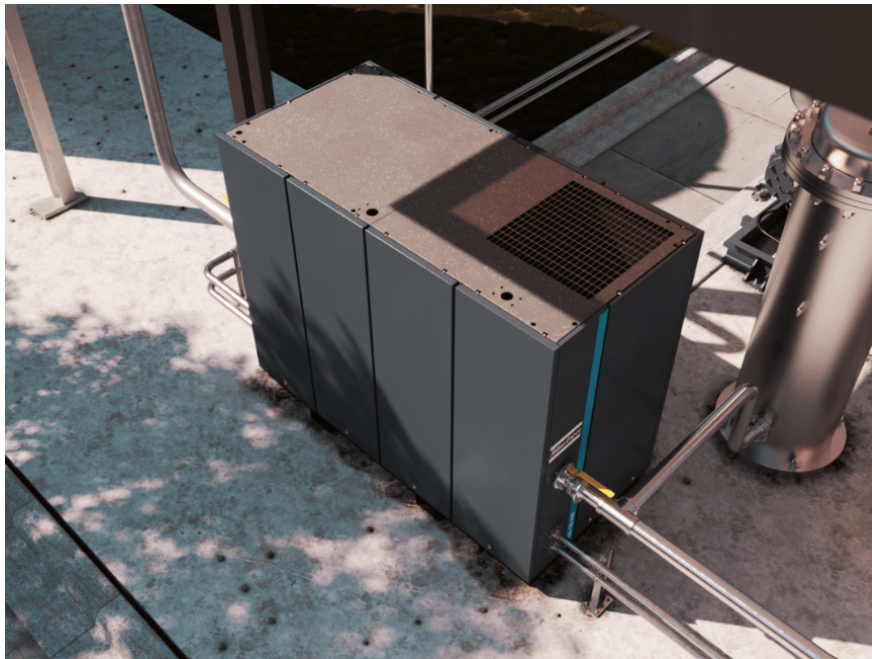

Features and options

FEATURES	OPTIONS
VSD electric motor IP55 – IEC – 400 V/50 Hz – Eexd IIB T4	Gas sensor
Lubricated rotary screw compressor	Outlet water separator
Water cooled heat exchangers	Inlet filter
Temperature and pressure sensors	Oil filtration
Pressure tight	Energy recovery
High security level (SIL 2) of critical functions	Wooden case protection packaging
Instrumentation for hazardous environment (ATEX Zone 2 / Class 1, Div. 2)	Electrical cabinet
Oil separator	Cable between electrical cabinet and compressor
Integrated SMARTLINK	Canopy/no canopy

Technical specifications

Main specifications (metric)

Model	Frequency	Inlet pressure		Outlet pressure	Flow		Installed power
	Hz	bar(g) (min)	bar(g) (max)	bar(g)	Nm ³ /h (min)	Nm ³ /h (max)	kW
GG 90 VSD	50	0.1	0.5	10	102	590	75
				15	63	483	
GG 132 VSD				10	173	1006	132
				15	154	793	

Main specifications (imperial)

Model	Frequency	Inlet pressure		Outlet pressure	Flow		Installed power
	Hz	psi(g) (min)	psi(g) (max)	psi(g)	scfm (min)	scfm (max)	hp
GG 90 VSD	60	1.4	7.2	145	64	368	100
				218	39	301	
GG 132 VSD				145	108	627	177
				218	96	494	

Weight and dimensions (metric)

Model	Weight	Length	Width	Height
	kg	mm		
GG 90-132 VSD without canopy, without gas filter, without Energy Recovery				
GG 90 VSD	1996	2846.5	1190	1500
GG 132 VSD	2249			1712
GG 90-132 VSD with canopy, with gas filter, with Energy Recovery				
GG 90 VSD	2284	2846.5	1190	2020
GG 132 VSD	2581			
Cubicle	350	1202	611.5	1903.5

Weight and dimensions (imperial)

Model	Weight	Length	Width	Height
	lbs	inch		
GG 90-132 VSD without canopy, without gas filter, without Energy Recovery				
GG 90 VSD	4401	121.5	46.9	59
GG 132 VSD	4959			67.4
GG 90-132 VSD with canopy, with gas filter, with Energy Recovery				
GG 90 VSD	5035	121.5	46.9	79.5
GG 132 VSD	5689			
Cubicle	772	47.3	24.1	74.9



Atlas Copco AB
(publ) SE-105 23 Stockholm, Sweden
Phone: +46 8 743 80 00
Reg. no: 556014-2720



WWW.ATLASCOPCO.COM

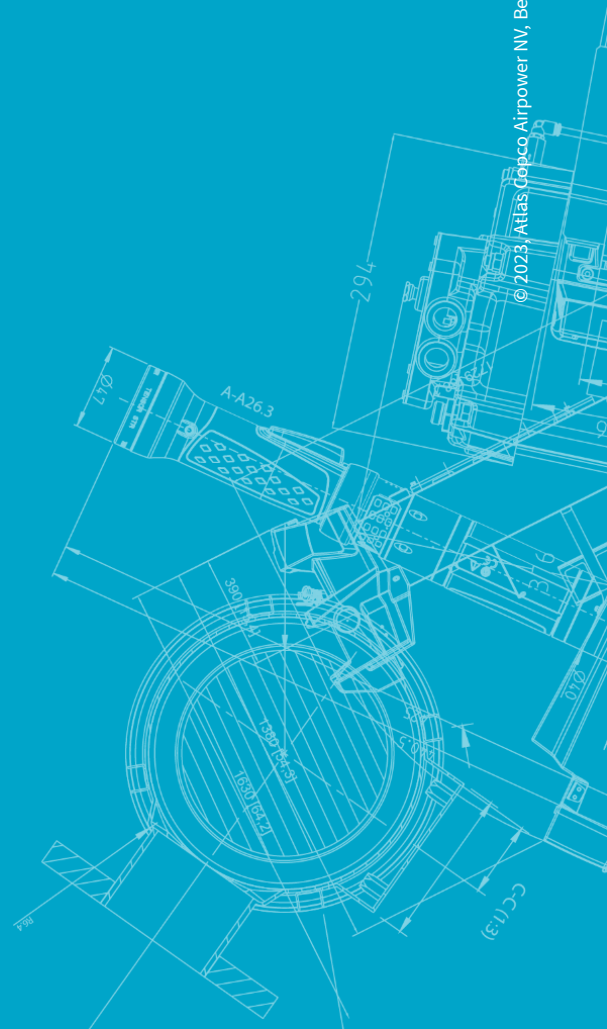

© 2023, Atlas Copco Airpower NV, Belgium. All rights reserved. Designs and specifications are subject to change without notice or obligation. Read all safety instructions in the manual before usage.