

Atlas Copco

# Oil-free Air high-speed centrifugal blowers

ZB 5/6/7 VSD+ – up to 1.4 bar(g) / 20 psi(g)- 20,000 m<sup>3</sup>/hr / 12,000 cfm

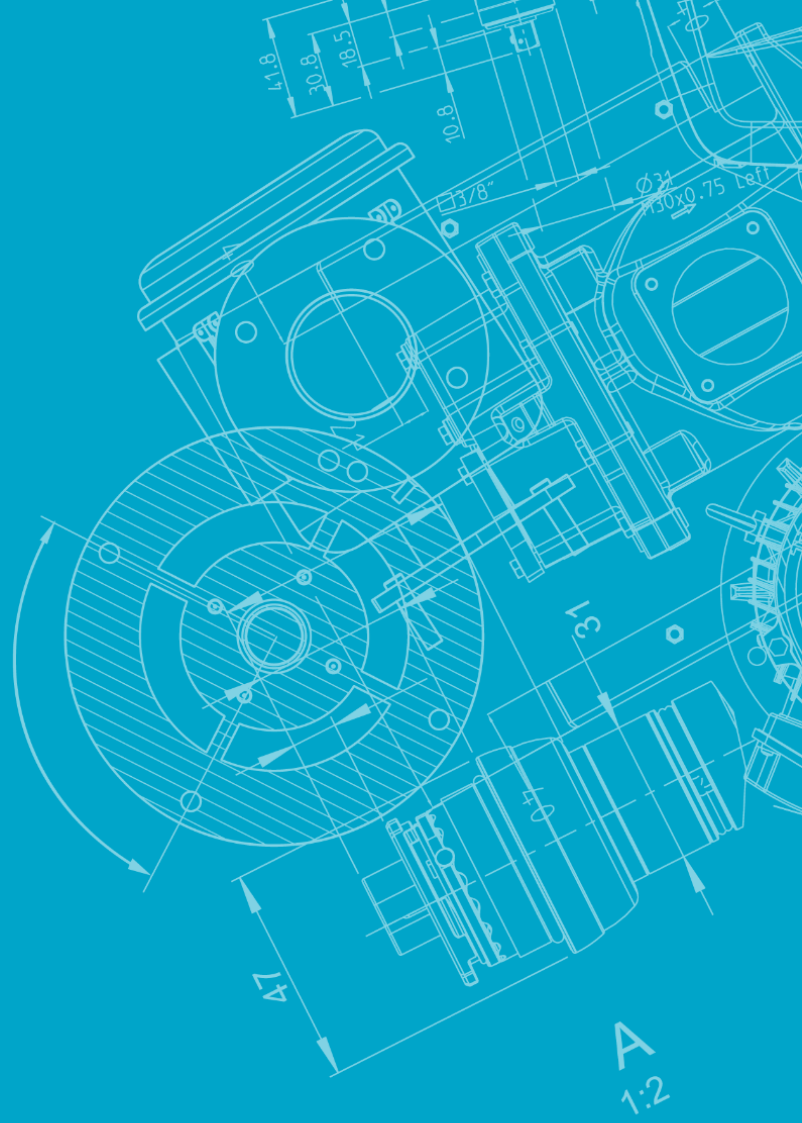



# Table of contents

**3**

ZB-Introduction

**5**

ZB-Markets

**6**

ZB-Air quality

**7**

ZB-Reliability

**14**

ZB-Efficiency

**16**

ZB-Installation

**17**

ZB-Service

**19**

ZB-Monitoring & control

**21**

ZB-Technical specifications

# A unique design with proven efficiency

---

With its new generation of ZB VSD+ magnetic bearing turbo blowers, Atlas Copco releases one of the most efficient oil-free turbo blowers in the market in all aspects. Paired with the highest efficiency, the ZB VSD+ range proves an incomparable reliability and lifetime with its unsensitivity to process changes.





## Durable technology, smart design

Using magnetic bearings for turbo blowers is the choice Atlas Copco made to ensure a complete peace of mind to users. As no air is used from the system to operate the machine, pressure variations will not trouble the operation of the blower at all. This technology combined with the fact that no power bank is needed in case of power failure makes the Atlas Copco ZB VSD+ one of the most straight forward magnetic bearing blowers ever made.



## Much more than turbo technology

Having a very efficient turbo technology is not enough. To really enhance its capacities every component has been designed and selected to deliver the best performance and the longest lifetime.



## No hidden surprises

Comparing blowers can be a hard and confusing job. Our motive is very simple: you will get what we quote. We don't want to confuse you with differences between inlet or delivered flow, shaft or package power. We will tell you exactly which flow and pressure our machines will produce for your process as well as how much electricity in total it will consume. If you are lost just call us and we will help you!



4 - ZB 5/6/7 VSD plus

# A perfect fit for all your applications

---

Not only the active magnetic bearing technology but also its complete design makes the ZB VSD+ range one of the most reliable turbo blowers in the market, ensuring a perfect fit for all your low pressure applications.



## Wastewater treatment

The ZB VSD+ blowers have a very wide flow and pressure operational range, making them suitable for different wastewater treatment applications. Typically, the major energy consumers in these plants are the blowers. ZB VSD+ however helps you to reduce your energy bill significantly thanks to the efficient impeller and bearing design.



## Pneumatic conveying

Conveying is a delicate process which needs 100% clean oil-free air for trouble-free and continuous operation. The ZB VSD+ blowers are a perfect fit for this kind of applications, ensuring energy-efficient Class 0 certified oil-free compressed air you can rely on.



## Fermentation

The ZB VSD+ provides 100% pure oil-free air for fermentation applications in the pharmaceutical or food & beverage industry. Class 0 certified ZB VSD+ blowers avoid compromising the purity of your end product and ensure zero risk of contamination by ensuring no oil is added during the compression process and thus delivering you 100% oil free air if the atmosphere doesn't contain any oil particles.



## Flue gas desulphurization

In coal-fired power plants, which are running 24/7, the compressed air solution needs to be highly reliable and no downtime can be permitted. With the ZB VSD+ blowers, you don't need to worry about this. They are designed to offer a constant reliable air flow at minimal energy cost.

# Class 0: the industry standard

---

Oil-free air is used in all kinds of industries where air quality is paramount for the end product and production process. These applications include wastewater treatment, food and beverage processing, pharmaceutical manufacturing and packaging, chemical and petrochemical processing, semiconductor and electronics manufacturing, the medical sector, automotive paint spraying, textile manufacturing and many more. In these critical environments, contamination by even the smallest quantities of oil can result in costly production downtime and product spoilage.



## First in oil-free air technology

Over the past sixty years Atlas Copco has pioneered the development of oil free air technology, resulting in a range of blowers that provide 100% pure, clean air. With our CLASS 0 products, no oil is added during the compression process, and thus provides you with 100% pure, clean air when the atmosphere doesn't contain any oil particles. Through continuous research and development, Atlas Copco achieved a new milestone, setting the standard for air purity as the first manufacturer to be awarded ISO 8573-1 CLASS 0 certification.

## Eliminating any risk

As the industry leader committed to meeting the needs of the most demanding customers, Atlas Copco requested the renowned TÜV institute to type-test its range of oil-free compressors and blowers. Using the most rigorous testing methodologies available, all possible oil forms were measured across a range of temperatures and pressures. The TÜV found no traces of oil at all in the output air stream. Thus Atlas Copco is not only the first compressor and blower manufacturer to receive CLASS 0 certification, but also exceeds ISO 8573-1 CLASS 0 specifications.

# High reliability



# ZB 5-6 VSD<sup>+</sup>

---

## FRONT VIEW



## BACK VIEW





## 1 Protecting electrical cubicle

The electrical cubicle combines one of the most advanced systems to ensure the machine's reliability as well as the network in which it is connected to:

- RFI filters reducing harmonic disturbances in the network
- AC chokes against high voltage peaks
- Unit controller
- High-frequency variable speed drive
- DC/DC converter energizing the magnetic bearing controller in case of power failure
- Magnetic bearing controller dynamically adjusting the blower's shaft position
- LC filters protecting the permanent magnet motor of harmonics

## 2 Compact and low heat rejection frequency drive

- The high-frequency variable speed drive is the component ensuring the motor's optimum operation
- Water-cooled, it provides minimum heat rejection and space requirement

## 3 Magnetic bearing controller

- Compiles information from position sensors to dynamically adjust the shaft's position
- Full control of the rotor is guaranteed by the magnetic force adjustment
- No external source required nor UPS in case of power failure. Energy is pulled from the variable frequency drive through a DC/DC converter.

## 4 Minimum internal temperature with heat exchanger cooling fan

- Reduces cooling water temperature for the permanent magnet motor and drive
- Cools down mechanical components inside the machine to ensure the lowest operating temperature and longest lifetime
- Centralized warm cooling air to one single common location on the machine's roof to ease ducting and heat extraction

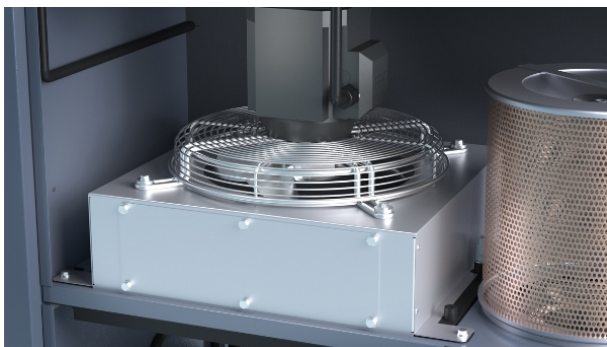

## 5 Actuated modulating blow-off valve

- Integrated and factory mounted modulating blow-off valve protecting the blower from overheating
- Assures smooth operation during rapid process changes
- Advanced control algorithm which allows the unit to run in the most efficient way in an extended operating flow range (from 100% to 0% turndown) and unlimited number of starts and stops



## 6 Integrated blow-off silencer

- Integrated and factory mounted blow-off silencer to reduce noise from blow-off operation
- Attenuated noise through built-in internal turns

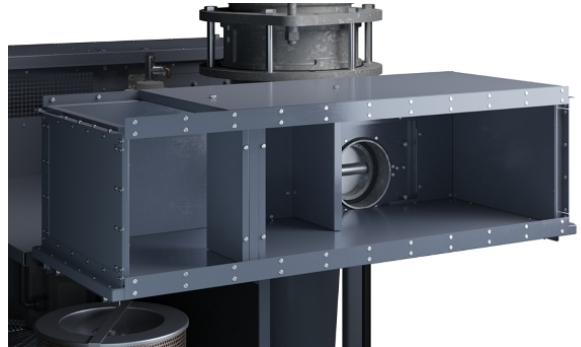

## 7 High-efficient process air filters

- Separated process air path to ensure lowest intake temperature and highest mass flow
- Parallel high-efficiency filters
- Easily accessible from the back of the machine and replaceable

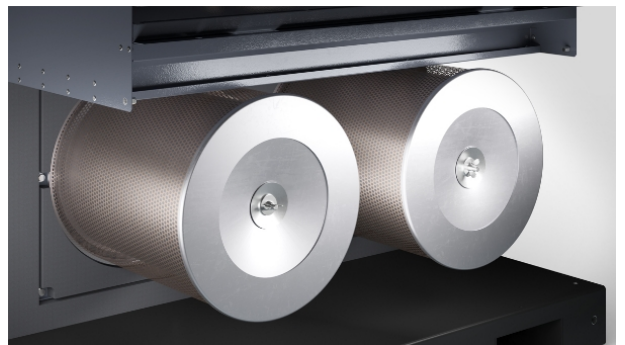

## 8 Separated process air inlet

- Manifold leading air directly from intake point to blower's impeller to separate it from internal heat
- Maintains the process air temperature to a minimum to increase mass flow delivered by the blower

## 9 Magnetic bearing turbo blower

- Magnetic bearing technology for highest reliability of all of your operations independently from the downstreams conditions
- Water-cooled permanent magnet motor maintaining the lowest running temperature and longest component lifetime

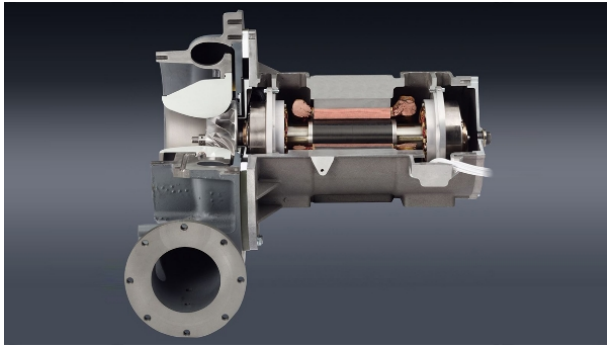

## 10 Check valve

- High-efficiency check valve to protect blower when not operating
- Lowest pressure drops to minimize the performance's impact

# ZB 7 VSD+

---

## FRONT VIEW



## BACK VIEW

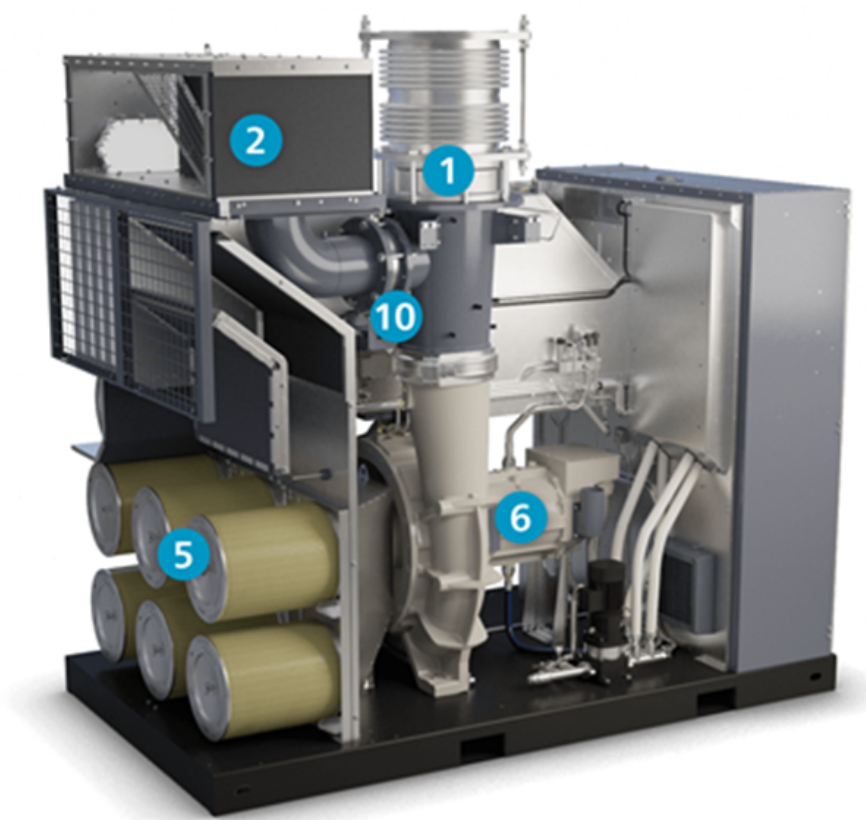

## 1 Check valve

- High-efficiency check valve to protect blower when not operating
- Lowest pressure drops to minimize the performance's impact



## 4 Separated process air inlet

- Manifold leading air directly from intake point to blower's impeller to separate it from internal heat
- Maintains the process air temperature to a minimum to increase mass flow delivered by the blower

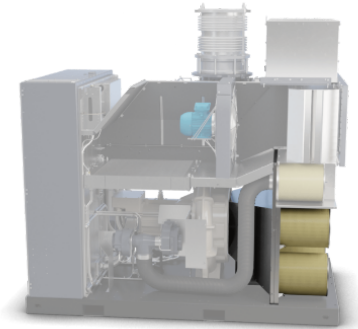

## 2 Integrated blow-off silencer

- Integrated and factory mounted blow-off silencer to reduce noise from blow-off operation
- Attenuated noise through built-in internal turns

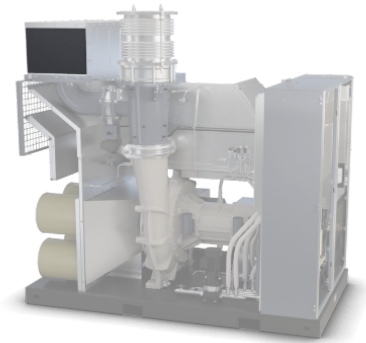

## 5 High-efficient process air filters

- Separated process air path to ensure lowest intake temperature and highest mass flow
- Parallel high-efficiency filters
- Easily accessible from the back of the machine and replaceable

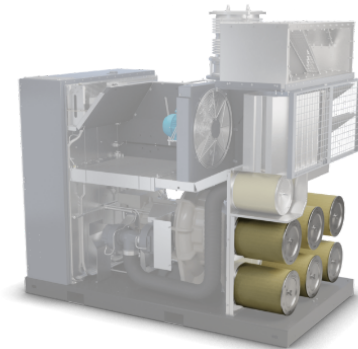

## 3 Minimum internal temperature with heat exchanger cooling fan

- Reduces cooling water temperature for the permanent magnet motor and drive
- Cools down mechanical components inside the machine to ensure the lowest operating temperature and longest lifetime
- Centralized warm cooling air to one single common location on the machine's roof to ease ducting and heat extraction

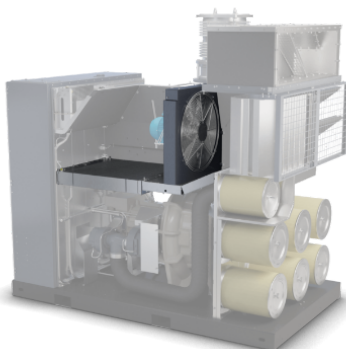

## 6 Magnetic bearing turbo blower

- Magnetic bearing technology for highest reliability of all of your operations independently from the down streams conditions
- Water-cooled permanent magnet motor maintaining the lowest running temperature and longest component lifetime

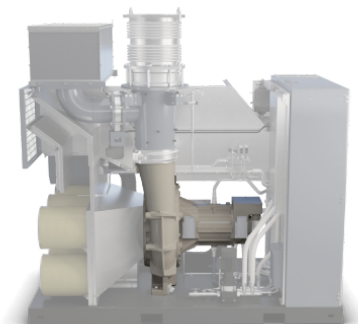

## 7 Compact and low heat rejection frequency drive

- The high-frequency variable speed drive is the component ensuring the motor's optimum operation
- Water-cooled, it provides minimum heat rejection and space requirement



## 9 Protecting electrical cubicle

The electrical cubicle combines one of the most advanced systems to ensure the machine's reliability as well as the network in which it is connected to:

- RFI filters reducing harmonic disturbances in the network
- AC chokes against high voltage peaks
- Unit controller
- High-frequency variable speed drive
- DC/DC converter energizing the magnetic bearing controller in case of power failure
- Magnetic bearing controller dynamically adjusting the blower's shaft position
- LC filters protecting the permanent magnet motor of harmonics



## 8 Magnetic bearing controller

- Compiles information from position sensors to dynamically adjust the shaft's position
- Full control of the rotor is guaranteed by the magnetic force adjustment
- No external source required nor UPS in case of power failure. Energy is pulled from the variable frequency drive through a DC/DC converter.



## 10 Actuated modulating blow-off valve

- Integrated and factory mounted modulating blow-off valve protecting the blower from overheating
- Assures smooth operation during rapid process changes
- Advanced control algorithm which allows the unit to run in the most efficient way in an extended operating flow range (from 100% to 0% turndown) and unlimited number of starts and stops

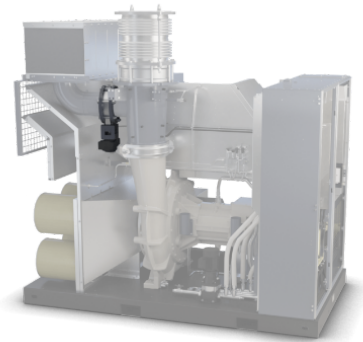

# Design & control algorithms for optimal efficiency

---

Did you know that compressed air generation amounts to over 60% of a plant's total electricity bill? And that energy consumption can account for over 90% of a blower's lifecycle cost? With Atlas Copco's new generation of ZB magnetic turbo blower, it helps businesses reduce energy consumption and increase their profits.



- Magnetic bearing technology for high efficiency operation without any physical contact means no mechanical friction or wear
- Direct connection of the impeller and motor, minimize the loss compared to conventional gear or belt drive.
- Premium labyrinth seal reducing leakages and energy losses over the compression stage

## Optimal cooling

Heat is a component's biggest enemy. It not only affects the lifetime but also the efficiency of the component. With the combination of both air cooling and water cooling, we offer you a high power range within one of the most compact and reliable designs. All key components (from the motor to the magnetic bearings) are operating at a low temperature, extending their lifetime compared to the typical existing cooling systems in the market. Both cooling systems are working independently from each other and from the external conditional fluctuations, making the module's internal temperature to be maintained constant at any conditions. The thermostatic valve together with the VSD driven cooler fan ensure that the cooling water of the motor and main frequency inverter reach an optimal temperature. By setting the temperature of the cooling water to an exact level, we optimize the efficiency and reliability of the motor and frequency inverter.





## Choosing the right impeller design

The impeller type material is crucial in defining the turndown and efficiency of your unit. The material, weight and shape (e.g. back leaning) of the impeller define the efficiency of the airflow and the power needed. E.g. a rough surface will cause more turbulence whilst a heavy impeller requires more power, making it less efficient. By offering a broad range of backward leaning impeller types with a dedicated design for each flow and pressure variant, our specialists can always offer you the most energy efficient solution for your application.

## IE 5 motor

All our units are equipped with motors reaching the IE 5 level. The IE 5 (International Efficiency 5) refers to a recognized and international standardized classification. The high IE 5 level of our motors helps to further reduce the energy consumption of the blower.

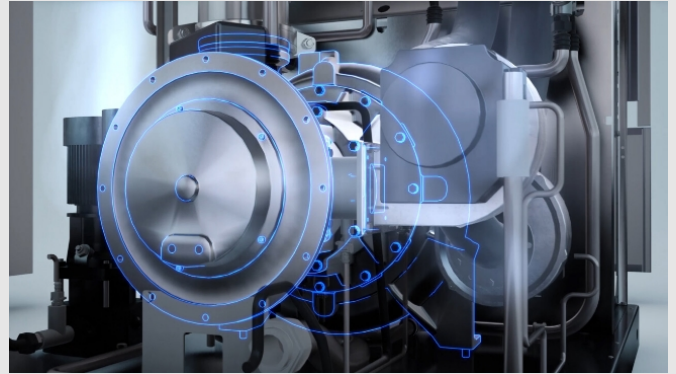

# Get your unit up and running as fast as possible

---

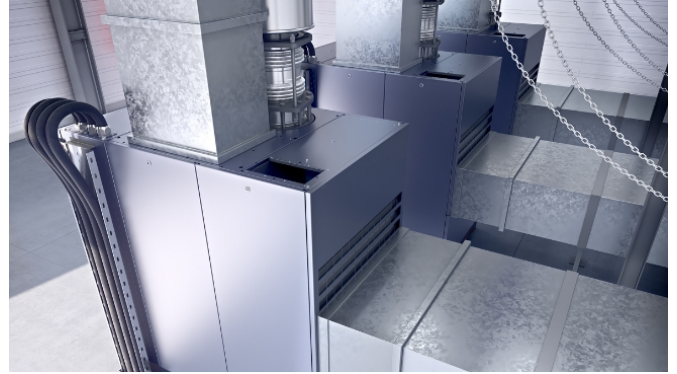

## Avoid unexpected costs with our plug & play units

We offer you the complete package with inlet filter, silencer, RFI filter, ... making sure our blowers are ready for operation upon arrival. Our plug & play solutions help you avoid unexpected costs as everything needed for operation is included in our offer. We guarantee you a small footprint: the dimensions of the unit stated on our offer are the final dimensions of the unit.

## Ducted cooling paths for even more savings

With the possibility to duct or pipe the inlet and outlet cooling air paths, even more energy savings can be aimed. With air coming from a colder location (outside of the blower room for example), its cooling capacity is even higher and requires the dedicated cooling fans to operate less. Also, directing the warm outlet air outside of the location where the blowers are installed will result in a smaller need of blower's room cooling and consequently lead to further energy savings. With these simple two connections, high savings can be considered in the long run!





# Maximize your resources with a Service Plan

Reduce your total cost of ownership and benefit from optimal performance. Optional maintenance will reduce the operational cost of your blower system. Operational efficiency is increased as our maintenance expertise makes life easier when it comes to resource management. Specialist services keeps your equipment running as it should, protecting your investment and guaranteeing high uptime and performance.

## Blower parts at your doorstep: our Parts Plan

Genuine Parts, designed and produced to the exact specifications of your blower, delivered right where and when you need them.

- **All parts, one package** – Always have the needed part for your service intervention at hand.
- **Save money** – A Service Kit costs less than the sum of its components if ordered separately.
- **Less administration** – Every Service Kit has a single part number, allowing you to create a simple purchase order that is easy to follow up.



## Fixed Price Services: best blower parts & maintenance

Avoid financial surprises. Our Fixed Price Services combine the expertise of factory-trained technicians with the quality of our genuine blower parts.

- **The best blower parts** – The unrivalled quality of our genuine parts results in optimal uptime, energy consumption and reliability.
- **An expert maintenance plan** – Rely on the expertise of factory-trained Atlas Copco technicians.
- **Clear and easy** – Tailored to your installation, site conditions, and production planning, every Fixed Price Service has a clear scope and price.

## Preventive Maintenance Plan for optimal blower uptime

Rely on trained Atlas Copco technicians and the unrivalled quality of our genuine parts.

- **Service reports** – We help you achieve maximum energy efficiency by keeping you up to date of the status of your system.
- **Prevent breakdown** – If our technicians spot an additional developing problem, they will propose a solution.
- **Top-priority emergency call out system** – If an urgent repair is needed, you get priority assistance.



## Complete blower care with our Total Responsibility Plan

We take care of all your blower maintenance, upgrades, repairs and even breakdowns for an all-inclusive price.

- **Complete blower care** – On-time maintenance by expert service engineers, genuine parts, proactive upgrades and blower overhauls.
- **Total risk coverage** – This means we take care of all your blower repairs and even breakdowns, without extra charges.
- **Ultimate efficiency** – Fitting the latest drive line components gives you as-new levels of compressor efficiency and reliability.

# Discover the different ways to control and monitor your unit

## Visual monitoring & control of each unit

### Elektronikon Mk5

The full color display gives you an easy-to-understand readout of the equipment's running conditions.

- Clear icons and intuitive navigation provides you fast access to all of the important settings and data.
- Monitoring of the equipment running conditions and maintenance status; bringing this information to your attention when needed.
- Operation of the equipment to deliver specifically and reliably to your compressed air needs.
- Built-in remote control- and notification functions provided as standard, including simple to use integrated webpage.
- Support for 31 different languages, including character based languages.



## Active control from start to end

Magnetic bearings are present to levitate the shaft but also to adjust its position. Sensors are located in three dimensions to measure the shaft's position. This information is sent to the controller which will adjust the shaft's position if needed by moving the magnetic force from one direction to another.

- In the starting phase, the shaft is levitated first. It avoids for the shaft to be rubbed to any part of the bearing, reducing its lifetime as it's the case with other turbo technologies.
- Once levitated, the shaft starts to spin until it reaches its targeted speed.
- To stop the shaft from spinning, the unit controller automatically brings it to a standstill position. After this, the shafts lands onto the back-up bearings which are mounted on damping material to soften this transition.

## Controlling multiple units

### Optimizer 4.0

A properly managed compressed air network will save energy, reduce maintenance, decrease downtime, increase production and improve product quality. Our Optimizer 4.0 monitors and controls the flow of multiple blowers simultaneously; it is one central point of control for the whole compressed air network, ensuring all blowers provide optimum performance for your process. The result is a completely autonomous and energy-efficient network, giving you peace of mind and keeping your costs minimized. Moreover, with our Industry 4.0 applications, you can access the information from your Optimizer wherever you are.

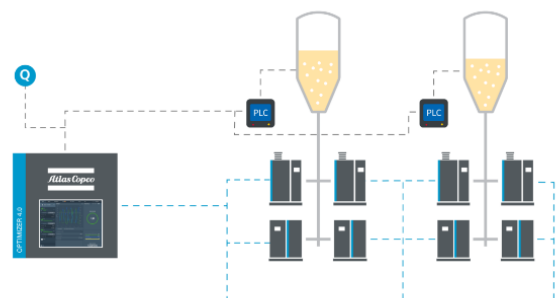



## Remote monitoring

### Monitor your compressed air installation with SMARTLINK

Knowing the status of your compressed air equipment at all times is the surest way to achieve optimal efficiency and maximum availability.



# Technical specifications

## ZB 5/6/7 VSD<sup>+</sup>

Type	Working pressure	Max. capacity FAD	Noise level (1)	Max. installed motor power	Dimensions	Weight
	mbar(g)	m <sup>3</sup> /hr	dB(A)	kW	L x W x H (mm)	kg
ZB 5 VSD <sup>+</sup>	1,400	6,000	69	140	1900 x 1200 x 1980	1,500
ZB 6 VSD <sup>+</sup>		12,000	74	250	2515 x 1200 x 1980	2,500
ZB 7 VSD <sup>+</sup>		20,000	77	400	2825 x 1600 x 2112	2,920

Type	Working pressure	Max. capacity FAD	Noise level (1)	Max. installed motor power	Dimensions	Weight
	psi(g)	cfm	dB(A)	hp	L x W x H (inch)	lb
ZB 5 VSD <sup>+</sup>	20	3,531	69	190	75 x 47 x 78	3,307
ZB 6 VSD <sup>+</sup>		7,062	74	335	99 x 47 x 78	5,512
ZB 7 VSD <sup>+</sup>		11,772	77	536	111 x 63 x 83	6,738



WWW.ATLASCOPCO.COM

**Atlas Copco AB**

(publ) SE-105 23 Stockholm, Sweden

Phone: +46 8 743 80 00

Reg. no: 556014-2720

